

Introduction

The IGS-9122GP is a managed industrial Ethernet switch with twelve 10/100/1000Base-T(X) ports and two 100/1000Base-X SFP ports. The Gigabit ports provide high network through puts to give your network the capacity to handle huge workloads. The SFP ports can meet demand for long-distance data transmission. The switch also supports Ethernet Redundancy protocol, O-Ring (recovery time <30 ms over 250 units of connection) and MSTP (RSTP/STP compatible) to protect mission-critical applications from network interruptions or temporary malfunctions with fast recovery technology. With a wide operating temperature from -40°C to 75°C, the device can be managed centrally via ORing's proprietary Open-Vision platform as well as via Web-based interfaces, Telnet, and console (CLI). The switch is one of the most reliable choices for highly-managed and fiber Ethernet applications.

Package Contents

The device is shipped with the following items. If any of these items is missing or damaged, please contact your customer service representative for assistance.

Contents	Pictures	Number
IGS-9122GP		X 1
CD		X 1
DIN-rail Kit		X 1
Wall-mount Kit		X 2
Console Cable		X 1
QIG		X 1

Preparation

Before you begin installing the switch, make sure you have all of the package contents available and a PC with Microsoft Internet Explorer 6.0 or later, for using web-based system management tools.

Safety & Warnings

- Elevated Operating Ambient:** If installed in a closed or multi-unit rack assembly, the operating ambient temperature of the rack environment may be greater than room ambient. Therefore, consideration should be given to installing the equipment in an environment compatible with the maximum ambient temperature (T_{ma}) specified by the manufacturer.
- Reduced Air Flow:** Installation of the equipment in a rack should be such that the amount of air flow required for safe operation of the equipment is not compromised.

- Mechanical Loading:** Mounting of the equipment in the rack should be such that a hazardous condition is not achieved due to uneven mechanical loading.
- Circuit Overloading:** Consideration should be given to the connection of the equipment to the supply circuit and the effect that overloading of the circuits might have on overcurrent protection and supply wiring. Appropriate consideration of equipment nameplate ratings should be used when addressing this concern.

Dimension

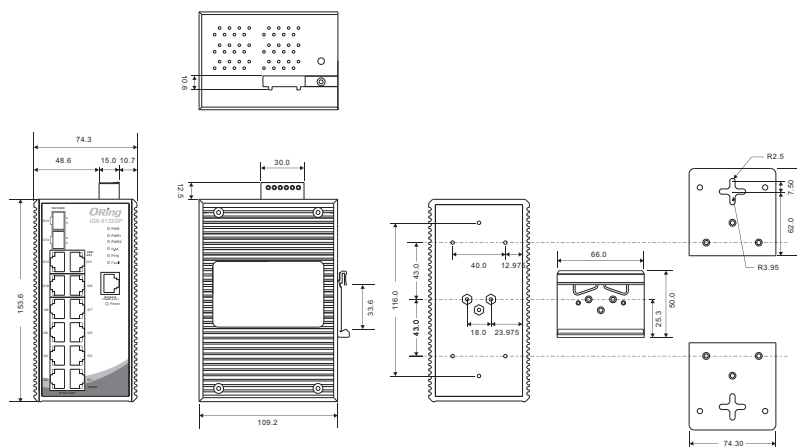

Panel Layouts

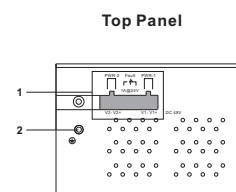
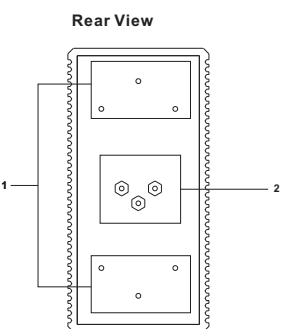
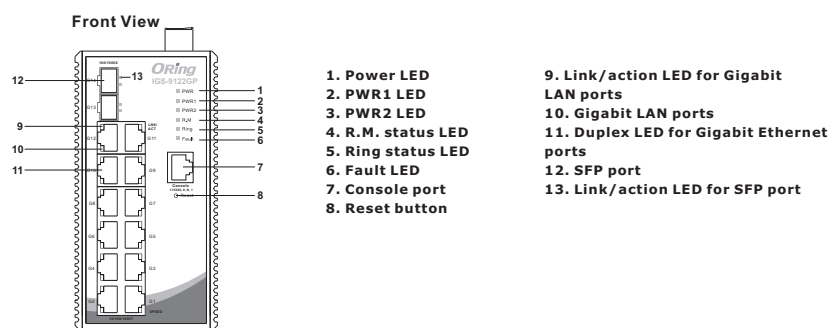

Installation

DIN-rail Installation

- Step 1:** Slant the switch and screw the Din-rail kit onto the back of the switch, right in the middle of the back panel.
- Step 2:** Slide the switch onto a DIN-rail from the Din-rail kit and make sure the switch clicks into the rail firmly.

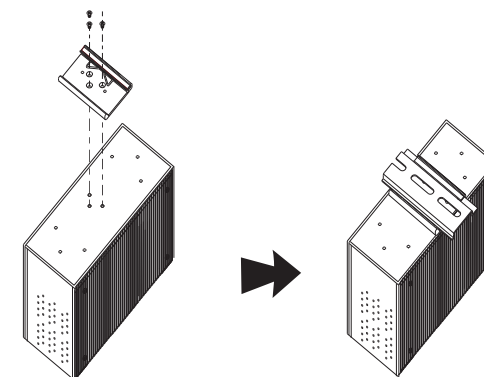

Wall-mounting

- Step 1:** Screw the two pieces of wall-mount kits onto both ends of the rear panel of the switch. A total of six screws are required, as shown below.
- Step 2:** Use the switch, with wall mount plates attached, as a guide to mark the correct locations of the four screws.
- Step 3:** Insert screws through the round screw holes (the red arrow as below) on the sides or through the cross-shaped aperture (the green arrow as below) in the middle of the plate and fasten the screw to the wall with a screwdriver.
- Step 4:** If the screw goes through the cross-shaped aperture, slide the switch down before tightening the screw.

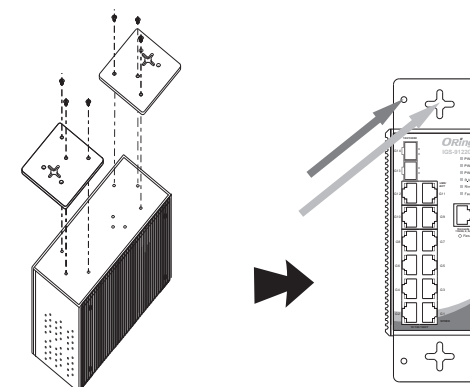

Network Connection

The switch provides standard Ethernet ports. According to the link type, the switch uses CAT 3, 4, 5, 5e UTP cables to connect to any other network devices (PCs, servers, switches, routers, or hubs). Please refer to the following table for cable specifications.

Cable Types and Specifications:

Cable	Type	Max. Length	Connector
10BASE-T	Cat. 3, 4, 5 100-ohm	UTP 100 m (328 ft)	RJ-45
100BASE-TX	Cat. 5 100-ohm UTP	UTP 100 m (328 ft)	RJ-45
1000BASE-T	Cat. 5 / Cat. 5e 100-ohm UTP	UTP 100 m (328 ft)	RJ-45

Configurations

After installing the switch, the green power LED should turn on. Please refer to the following table for LED indication.

LED	Color	Status	Description
PWR	Green	On	System power on
PW1	Green	On	Power module 1 activated
PW2	Green	On	Power module 2 activated
R.M	Green	On	System operated in O-Ring Master mode
Ring	Green	On	System operated in O-Ring mode
		Blinking	Ring structure is broken
Fault	Amber	On	Errors occur (power failure or ports disconnected)

10/100/1000Base-T(X) Fast Ethernet ports			
LNK/ACT	Color	Status	Description
LNK/ACT	Green	On	Port is Linked
		Blinking	Transmitting data
Speed	Green	On	Port link at 1000Mbps
		Amber	Port link at 100Mbps
		Green/Amber	Port link at 10Mbps

SFP ports			
LNK/ACT	Color	Status	Description
LNK/ACT	Green	On	Port is linked
		Blinking	Transmitting data

Follow the steps to set up the switch:

1. Launch the Internet Explorer and type in IP address of the switch. The default static IP address is **192.168.10.1**

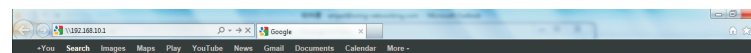

2. Log in with default user name and password (both are **admin**). After logging in, you should see the following screen. For more information on configurations, please refer to the user manual. For information on operating the switch using ORing's Open-Vision management utility, please go to ORing website.



Resetting

To reboot the switch, press the **Reset** button for 2-3 seconds.

To restore the switch configurations back to the factory defaults, press the **Reset** button for 5 seconds.

Specifications

ORing Switch Model	IGS-9122GP
Physical Ports	
10/100/1000Base-T(X) Ports in RJ45 Auto MDI/MDIX	12
100/1000Base-X with SFP port	2
Technology	
Ethernet Standards	IEEE 802.3 for 10Base-T IEEE 802.3u for 100Base-TX and 100Base-FX IEEE 802.3z for 1000Base-X IEEE 802.3ab for 1000Base-T IEEE 802.3ad for LACP (Link Aggregation Control Protocol) IEEE 802.3x for Flow control IEEE 802.1p for COS (Class of service) IEEE 802.1Q for VLAN Tagging IEEE 802.1w for RSTP (Rapid Spanning Tree Protocol) IEEE 802.1s for MSTP (Multiple Spanning Tree Protocol) IEEE 802.1x for Authentication IEEE 802.1AB for LLDP (Link Layer Discovery Protocol)
MAC Table	8K
Priority Queues	8
Processing	Store-and-Forward
Switch Properties	Switch latency: 7 us Switch bandwidth: 28Cbps Max. Number of Available VLANs: 256 VLAN ID Range: VID 1 to 4094 IGMP multicast groups: 128 for each VLAN Port rate limiting: User Define
Jumbo frame	Up to 9.6K Bytes
Security Features	Device Binding security feature Enable/disable ports, MAC based port security Port based network access control (802.1x) VLAN (802.1q) to segregate and secure network traffic Radius centralized password management SNMPv3 encrypted authentication and access security Https / SSH enhance network security
Software Features	STP/RSTP/MSTP (IEEE 802.1D/w/s) Redundant Ring (O-Ring) with recovery time less than 10ms over 250 units TOS/Diffserv supported Quality of Service (802.1p) for real-time traffic VLAN (802.1q) with VLAN tagging and GVRP supported IGMP Snooping for multicast filtering IP-based bandwidth management Application-based QoS management DOS/DDOS auto prevention Port configuration, status, statistics, monitoring, security DHCP Server / Client support SMTP Client Modbus TCP
Network Redundancy	O-Ring, Open-Ring, O-chain, MRP, MSTP (RSTP/STP compatible)
RS-232 Serial Console Port	RS-232 in RJ45 connector with console cable. 115200bps, 8, N, 1 (support backup unit)
Fault contact	
Relay	Relay output to carry capacity of 1A at 24VDC
Power	
Redundant Input power	Dual DC inputs. 12~48VDC on 6-pin terminal block
Power consumption(Typ.)	12.67 Watts
Overload current protection	Present
Reverse polarity protection	Present
Physical Characteristic	
Enclosure	IP-30
Dimension (W x D x H)	74.3 (W) x 109.2(D) x 153.6(H) mm (2.93 x 4.3 x 6.05 inch)
Weight (g)	1160 g
Environmental	
Storage Temperature	-40 to 85°C (-40 to 185°F)
Operating Temperature	-40 to 75°C (-40 to 167°F)
Operating Humidity	5% to 95% Non-condensing
Regulatory Approvals	
EMI	FCC Part 15, CISPR (EN55022) class A
EMS	EN61000-4-2 (ESD), EN61000-4-3 (RS), EN61000-4-4 (EFT), EN61000-4-5 (Surge), EN61000-4-6 (CS), EN61000-4-8, EN61000-4-11
Shock	IEC60068-2-27
Free Fall	IEC60068-2-32
Vibration	IEC60068-2-6
Safety	EN60950-1
Warranty	5 years

For pin assignments for different types of cables, please refer to the following tables.

10/100 Base-T(X) RJ-45 Port		1000Base-T RJ-45 Port	
Pin Number	Assignments	Pin Number	Assignment
1	TD+	1	BI_DA+
2	TD-	2	BI_DA-
3	RD+	3	BI_DB+
4	Not used	4	BI_DC+
5	Not used	5	BI_DC-
6	RD-	6	BI_DD-
7	Not used	7	BI_DD+
8	Not used	8	BI_DD-

10/100 Base-T(X) MDI/MDI-X			1000Base-T MDI/MDI-X		
Pin Number	MDI port	MDI-X port	Pin Number	MDI port	MDI-X port
1	TD+(transmit)	RD+(receive)	1	BI_DA+	BI_DB+
2	TD-(transmit)	RD-(receive)	2	BI_DA-	BI_DB-
3	RD+(receive)	TD+(transmit)	3	BI_DB+	BI_DA+
4	Not used	Not used	4	BI_DC+	BI_DD+
5	Not used	Not used	5	BI_DC-	BI_DD-
6	RD-(receive)	TD-(transmit)	6	BI_DB-	BI_DA-
7	Not used	Not used	7	BI_DD+	BI_DC+
8	Not used	Not used	8	BI_DD-	BI_DC-

Note: "+" and "-" signs represent the polarity of the wires that make up each wire pair.

Console Port Pin Definition

To connect the console port to an external management device, you need an RJ-45 to DB-9 cable, which is also supplied in the package. Below is the console port pin assignment information.

PC (male) pin assignment	RS-232 with DB9 (female) pin assignment (RJ45-DB9 cable)	RJ45 pin assignment
PIN#2 Rx/D	PIN#2 Rx/D	PIN#2 Rx/D
PIN#3 Tx/D	PIN#3 Tx/D	PIN#3 Tx/D
PIN#5 GND	PIN#5 GND	PIN#5 GND

Wiring

Power inputs

The switch supports dual redundant power supplies, Power Supply 1 (PWR1) and Power Supply 2 (PWR2). The connections for PWR1, PWR2 and the RELAY are located on the terminal block.

STEP 1: Insert the negative/positive wires into the V-/V+ terminals, respectively.

STEP 2: To keep the DC wires from pulling loose, use a small flat-blade screwdriver to tighten the wire-clamp screws on the front of the terminal block connector.

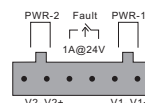

Relay contact

The two sets of relay contacts of the 6-pin terminal block connector are used to detect user-configured events. The two wires attached to the fault contacts form an open circuit when a user-configured when an event is triggered. If a user-configured event does not occur, the fault circuit remains closed.

Grounding

Grounding and wire routing help limit the effects of noise due to electromagnetic interference (EMI). Run the ground connection from the ground screws to the grounding surface prior to connecting devices.

ORing

Copyright© 2015 ORing
All rights reserved.

ORing Industrial Networking Corp.
TEL: +886-2-2218-1066 Website: www.oring-networking.com
FAX: +886-2-2218-1014 E-mail: support@oring-networking.com