

VISION120™ Full-function PLC with built-in, monochrome graphic LCD display, keypad, & onboard I/O configuration; expand up to 256 I/Os

Features:

HMI

- Up to 255 user-designed screens
- Hundreds of images per application
- HMI graphs & Trends
- Memory and communication monitoring via HMI - No PC needed

PLC

- I/O options include high-speed, temperature & weight measurement
- Auto-tune PID, up to 12 independent loops
- Recipe programs and datalogging via Data Tables
- Date & Time-based control

Communication

- SMS messaging
- GPRS/GSM
- Remote Access utilities
- MODBUS protocol support
- CANbus: CANopen, UniCAN, SAE J1939 NOT FOR V2XX, only Enhanced (in C models only)
- FB Protocol Utility: enables serial or TCP/IP communications with 3rd-party device; barcode readers, frequency converters, etc
- 2 RS232/RS485 built-in ports



V120

“The Vision120™ met and exceeded all our requirements in one compact, cost-effective package.”



David Wong,
President of NEXTChem

		V120								
Article Number	V120-22-R1	V120-22-R2C	V120-22-R6C	V120-22-R34	V120-22-T1	V120-22-T38	V120-22-T2C	V120-22-UN2	V120-22-UA2	V120-22-RA22
	10 Digital 1 Analog Inputs 6 Relay Outputs	10 Digital 2 Analog Inputs 6 Relay Outputs	6 Digital 6 Analog Inputs 6 Relay Outputs	20 Digital 2 D/A ¹ Inputs 12 Relay Outputs	12 Digital Inputs 12 Transistor Outputs	22 Digital Inputs 16 Transistor Outputs	10 Digital 2 D/A ¹ Inputs 12 Transistor Outputs	10 Digital 2 D/A/PT100/ TC ¹ Inputs 12 Transistor Outputs	10 Digital 2 D/A/TC ¹ Inputs 10 Transistor 2 Analog Outputs	8 Digital 2 D/A, 2 PT100/ TC/Digital ¹ Inputs 8 Relay 2 Analog Outputs
Inputs										
Digital pnp/npn	10	10	6	22	12	22	12	12	12	12
HSC/Shaft-Encoder/ Max Freq. Measurer ²	3 10kHz 32-bit	3 10kHz 32-bit	1 10kHz 32-bit	3 10kHz ³ 32-bit	2 10kHz 32-bit	2 10kHz ³ 32-bit	3 10kHz 32-bit	2 10kHz 32-bit	1 10kHz ³ 32-bit	1 10kHz ³ 32-bit
Analog	1 10-bit 0-10V, 0-20mA 4-20mA	2 10-bit 0-10V, 0-20mA 4-20mA	6 10-bit, 2 0-10V 0-20mA, 4-20mA and 4 0-20mA 4-20mA	2 10-bit 0-10V, 0-20mA 4-20mA	None	None	2 10-bit 0-10V 0-20mA 4-20mA	2 14-bit 0-10V, 0-20mA 4-20mA or 2 PT100/TC	2 14-bit 0-10V, 0-20mA 4-20mA or 2 TC	2 14-bit 0-10V, 0-20mA 4-20mA and 2 PT100/TC
Temperature Measurement	None	None	None	None	None	None	None	None	None	None
Outputs										
Digital	6 relay	6 relay	6 relay	12 relay	12 pnp	16 pnp	12 pnp	12 pnp	10 pnp	8 relay
High-Speed Outputs/ PWM ⁴	None	None	None	None	2, first 2 outputs can function as HSO, 0.5kHz maximum					None
Analog	None	None	None	None	None	None	None	None	2 12-bit 0-10V, 4-20mA	2 12-bit 0-10V, 4-20mA
I/O Expansions										
Local or Remote I/Os may be added via expansion port or via CANbus										
Program										
Application Memory	448K (virtual) Ladder code capacity									
Memory Scan Time	48µ sec per 1K of typical application									
Operands	4096 coils, 2048 registers, 256 long integers (32-bit), 64 double words (32-bit unsigned), 24 floats, 192 timers (32-bit), 24 counters									
Data Tables	120K dynamic RAM data (recipe parameters, datalogs, etc.), up to 256K fixed data									
Operator Panel										
Type	Graphic STN LCD									
Display	Resolution: 128 x 64 pixels • Size: 2.4"									
Keys	16 keys									
General										
Power Supply	12/24VDC	12/24VDC	24VDC	24VDC	12/24VDC	24VDC	12/24VDC	12/24VDC	24VDC	24VDC
Battery	7 years typical at 25°C, battery back-up for all memory sections and RTC									
Clock	Real-time clock functions (date and time)									
Environment	IP65/NEMA4X (when panel mounted)									
standard	CE, UL Many of our products are also UL Class 1 Div 2 and GOST certified - please contact Unitronics									

¹ In these models certain inputs are adaptable, and can function as either digital, analog, and in certain models also as thermocouple or PT100. Using adaptable inputs reduces the amount of free digital inputs. For example, V120-22-UA2 offers 12 digital inputs. Implementing 2 TC inputs requires 4 digital inputs, leaving 8 free.

² Certain inputs can function as high-speed counters, shaft-encoder inputs, or normal digital inputs.

³ This specification depends on cable length.

⁴ Certain outputs can function as high-speed or PWM outputs.

V120-22-T2C

Art. No. 1\$, +*\$

Graphic Operator Panel & Programmable Logic Controller

12/24VDC, 12 pnp/npn digital inputs, 2 analog inputs, 3 high-speed counter/shaft encoder inputs, 12 transistor outputs, I/O expansion port, RS232/RS485 plus CANbus

Power supply	12VDC or 24VDC
Permissible range	10.2VDC to 28.8VDC with less than 10% ripple
Maximum current consumption	130mA@24VDC (pnp inputs) 230mA@24VDC (npn inputs) 250mA@12VDC (pnp inputs) 290mA@12VDC (npn inputs)
Digital inputs	12 pnp (source) or npn (sink) inputs. See Notes 1 and 2.
Nominal input voltage	12VDC or 24VDC. See Notes 3 and 4.
Input voltages for pnp (source):	
For 12VDC	0-3VDC for Logic '0' 8-15.6VDC for Logic '1'
For 24VDC	0-5VDC for Logic '0' 17-28.4VDC for Logic '1'
Input voltages for npn (sink):	
For 12VDC	8-15.6VDC/<1.2mA for Logic '0' 0-3VDC/>3mA for Logic '1'
For 24VDC	17-28.4VDC/<2mA for Logic '0' 0-5VDC/>6mA for Logic '1'
Input current	4mA@12VDC 8mA@24VDC
Input impedance	3KΩ
Response time (except high-speed inputs)	10mS typical
Galvanic isolation	None
Input cable length	Up to 100 meters, unshielded
High-speed counter	Specifications below apply when inputs are wired for use as a high-speed counter input/shaft encoder. See Notes 5 and 6.
Resolution	32-bit
Input freq.	10kHz max.
Minimum pulse	40μs

Notes:

- All 12 inputs can be set to pnp (source) or npn (sink) via a single jumper and appropriate wiring.
- Inputs #10 and #11 can function as either digital inputs or as analog inputs, via a single jumper and appropriate wiring.
- All 12 inputs can function in 12 VDC or 24 VDC; set via a single jumper and appropriate wiring.
- npn (sink) inputs use voltage supplied from the controller's power supply.
- Inputs #0, #2 and #4 can each function as either high-speed counter or as part of a shaft encoder. In each case, high-speed input specifications apply. When used as a normal digital input, normal input specifications apply.
- Inputs #1, #3 and #5 can each function as either counter reset, or as a normal digital input; in either case, specifications are those of a normal digital input. These inputs may also be used as part of a shaft encoder. In this case, high-speed input specifications apply.

Shaft encoder

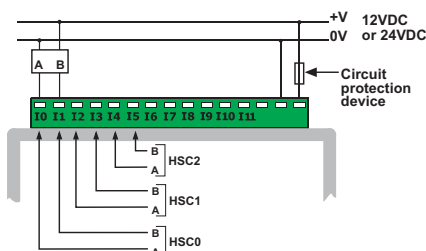

Power supply, pnp (source) inputs

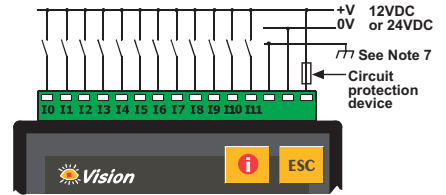

Note 7:

To avoid electromagnetic interference, mount the controller in a metal panel/cabinet and earth the power supply. Earth the power supply signal to the metal using a wire whose length does not exceed 10cm. If your conditions do not permit this, do not earth the power supply.

npn (sink) inputs

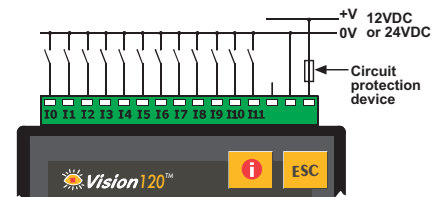

pnp (source) high-speed counter

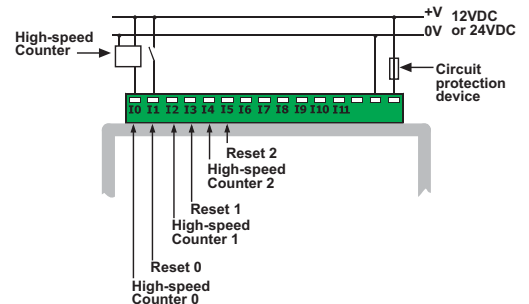

npn (sink) high-speed counter

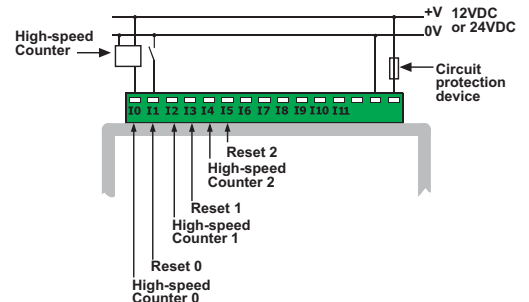

Warnings:

- Unused pins should not be connected. Ignoring this directive may damage the controller.
- Improper use of this product may severely damage the controller.
- Refer to the controller's User Guide regarding wiring considerations.
- Before using this product, it is the responsibility of the user to read the product's User Guide and all accompanying documentation.

Analog Inputs	Two 10-bit, multi-range inputs: 0-10V, 0-20mA, 4-20mA See Note 2.
Conversion method	Successive approximation
Input impedance	>1M Ω for voltage 243 Ω for current
Galvanic isolation	None
Resolution (except 4-20mA)	10-bit (1024 units)
Resolution at 4-20mA	204 to 1023 (820 units)
Conversion time	Synchronized to scan time
Absolute max. rating	$\pm 15V$
Full scale error	± 2 LSB
Linearity error	± 2 LSB
Status indication	Yes, see Note 8

Note 8:

The analog value can also indicate when the input is functioning out of range. If an analog input deviates above the permissible range, its value will be 1024.

Voltage / Current connection

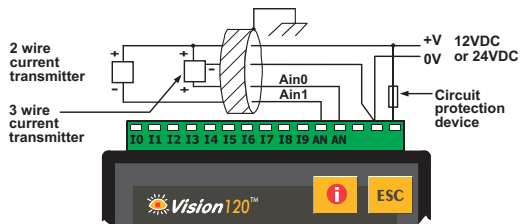
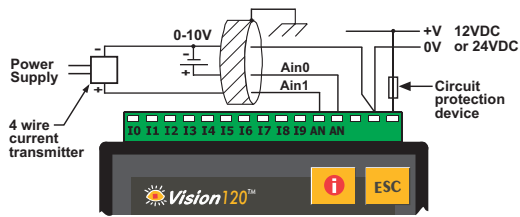

Note 9:

Voltage current connection shields should be connected at the signals' source. The 0V signal of the analog input must be connected to the controller's 0V.

Digital outputs	12 pnp (source) outputs 12VDC or 24VDC
Output type	P-MOSFET (open drain)
Isolation	None
Output current	0.5A max. Total current: 3A max.
Max. frequency for normal outputs	50Hz (resistive load) 0.5Hz (inductive load)
High speed output maximum frequency	2kHz (resistive load) See Note 10.
Short circuit protection	Yes
Short indication	by software
On voltage drop	0.5VDC maximum
Power supply for outputs	
Operating voltage	10.2 to 28.8VDC
Nominal operating voltage	12VDC or 24VDC

Note 10:

Output #0 and Output #1 may be used as high-speed outputs.

Outputs connection

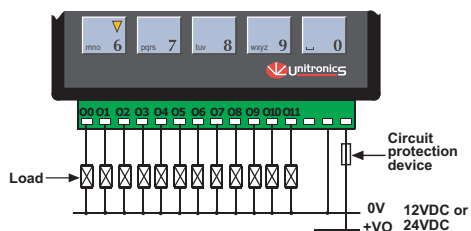

Graphic Display	STN, LCD display
Illumination backlight	LED, yellow-green, software-controlled
Display resolution	128x64 pixels
Keypad	Sealed membrane
Number of keys	16
Program	
Application Memory	448K
Memory Bits (coils)	2048
Memory Integers (registers)	1600
Long Integers (32 bit)	256
Double Word (32 bit unsigned)	64
Floats	24
Timers	192
Counters	24
Data Tables	120K (RAM) / 64K (FLASH)
HMI displays	Up to 255
Execution time	0.8 μ s for bit operations

RS232/RS485 serial port	Used for: <ul style="list-style-type: none"> Application Download/Upload Application Testing (Debug) Connect to GSM or standard telephone modem: <ul style="list-style-type: none"> Send/receive SMS messages Remote access programming RS485 Networking
RS232 (See Note 11)	2 ports
Galvanic isolation	None
Voltage limits	$\pm 20V$
RS485 (See Note 11)	1 port
Input voltage	-7 to +12V differential max.
Cable type	Shielded twisted pair, in compliance with EIA RS485
Galvanic isolation	None
Baud rate	110 – 57600 bps
Nodes	Up to 32

Note11:

RS232/RS485 is determined by jumper settings and wiring. Refer to the controller's User Guide regarding communications.

I/O expansion port	Up to 128 additional I/Os, including digital & analog I/Os, RTD and more.
---------------------------	---

CANbus port	Up to 63 nodes
Baud rate range	20Kbps - 1Mbps
Cable length	Up to 150m for 12VDC network Up to 1000m for 24VDC network

CANbus connection

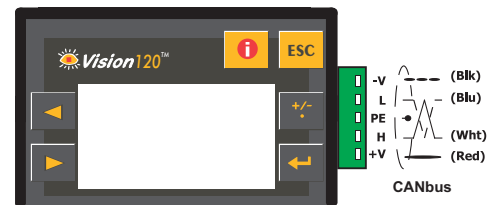

Miscellaneous	
Clock (RTC)	Real-time clock functions. (Date and Time)
Battery back-up	7 years typical battery back-up for RTC and system data.
Weight	240g (8.46 oz.)
Operational temperature	0 to 50°C (32 to 122°F)
Storage temperature	-20 to 60°C (-4 to 140°F)
Relative Humidity (RH)	5% to 95% (non-condensing)
Mounting method	DIN-rail mounted (IP20/NEMA1) Panel mounted (IP65/NEMA4X)

V120-22-T2C

I/O Jumper Settings

The tables below show how to set a specific jumper to change the functionality of the controller. To open the controller and access the jumpers, refer to the directions at the end of these specifications.

Important:

Incompatible jumper settings and wiring connections may severely damage the controller.

JP1 Digital Inputs type

To use as	JP1
nnp (sink)	A
pnp (source)*	B

JP2 Inputs voltage

To use as	JP2
12VDC	A
24VDC*	B

*Default factory setting

JP3, JP4 Analog inputs type

To use as	JP3 for analog input #1	JP4 for analog input #0
Voltage input*	A	A
Current input	B	B

JP5, JP6 Digital/Analog inputs

Range	JP5 for AN1 / In#10	JP6 for AN0 / In#11
Digital inputs*	A	A
Analog inputs	B	B

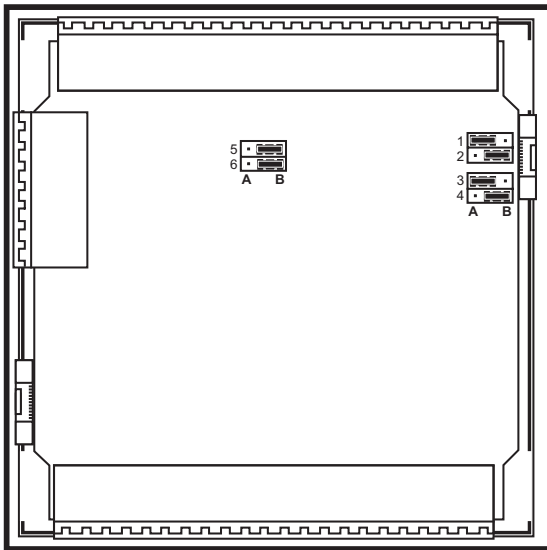

In this figure, the jumper settings will cause the controller to function as follows:

- Digital inputs: npn, 24VDC inputs
- Analog input #0: Voltage input
- Analog input #1: Current input

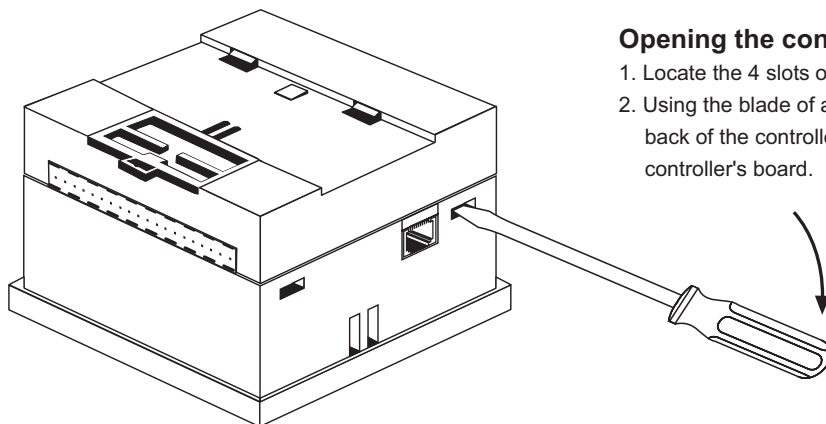

Opening the controller enclosure

1. Locate the 4 slots on the sides of the enclosure
2. Using the blade of a flat-bladed screwdriver, gently pry off the back of the controller as shown in the figure below, exposing the controller's board.

Unitronics reserves the right to revise this publication from time to time and to amend its contents and related hardware and software at any time. Technical updates (if any) may be included in subsequent editions (if any).

Unitronics product sold hereunder can be used with certain products of other manufacturers at the user's sole responsibility.