

UA-5200 IIoT Communication Server

UA-5231

UA-5231M

UA-5231M-3GWA

Features

- OPC UA Server and MQTT Client Service
- MQTT Broker Inside
- ARM CPU, 1.0 GHz
- 512 MB RAM and 512 MB Flash
- Linux kernel 3.2.14 OS
- Real-Time Capability
- 64-bit Hardware Serial Number for Software Protection
- Support Redundancy (OPC UA) and PID
- 10/100/1000 Mbit/s Ethernet Port
- 4 Serial Ports (RS-232/RS-485)
- Operating Temperature: -25 ~ +75°C

Introduction

The **UA-5200** series is an IIoT communication server (IIoT: Industrial Internet of Things) with the data acquisition and control functions by ICP DAS. It has built-in **OPC UA** server, **MQTT** broker and client driver to meet the need to connect to the MES, ERP, SCADA and cloud service. And with the Ethernet, RS-232, RS-485 interfaces and Modbus TCP/RTU/ASCII protocol, the UA-5200 series can access regular remote I/O modules or controllers that already widely used in the factory. With the UA-5200 series, it becomes very easy to make things used in the factory connect to MES, ERP, SCADA and cloud.

Applying the **OPC UA**, the UA-5200 can integrate the I/O products and the third-party devices, import their data to the back-end SCADA management system or the big-data analysis/decision system, to satisfy the reliability, interoperability and security needs of the Industrial 4.0 automation system. Using the **MQTT** active communications to bridge the Internet of Things (IoT) and transmit the statuses of various devices by the cloud-based interaction so that to meet the current trend of the IIoT and achieve the full smart automation system based on **Industry 4.0**.

System Integration Main Architecture

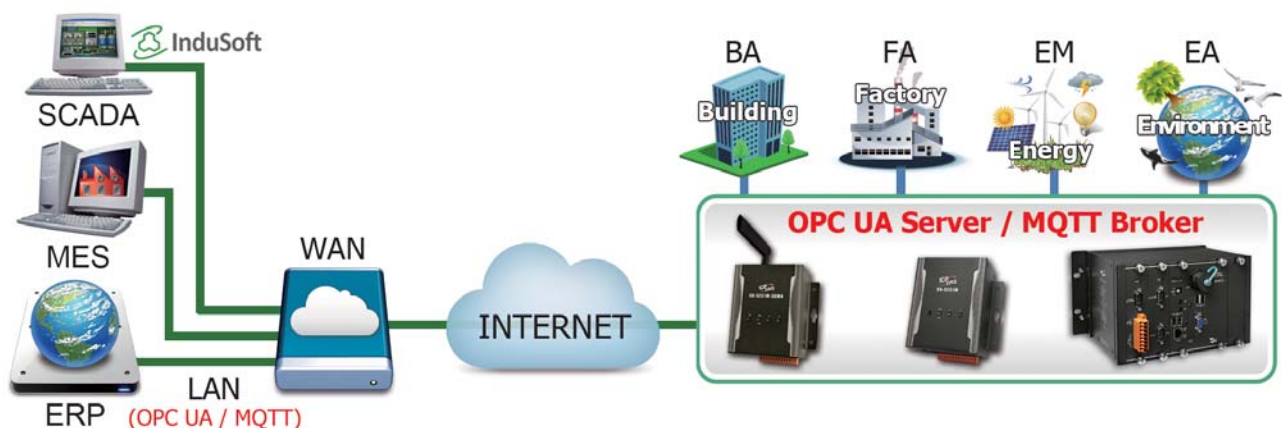

Cloud Integration Architecture

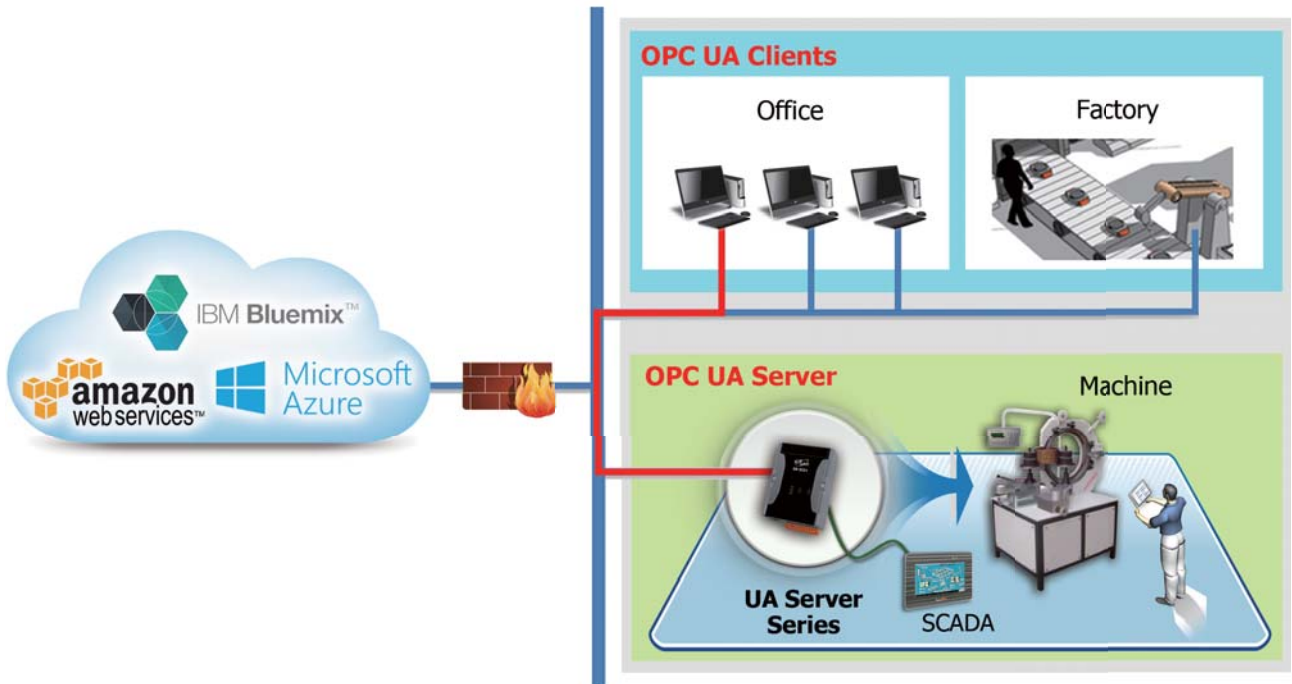

Device Integration Architecture

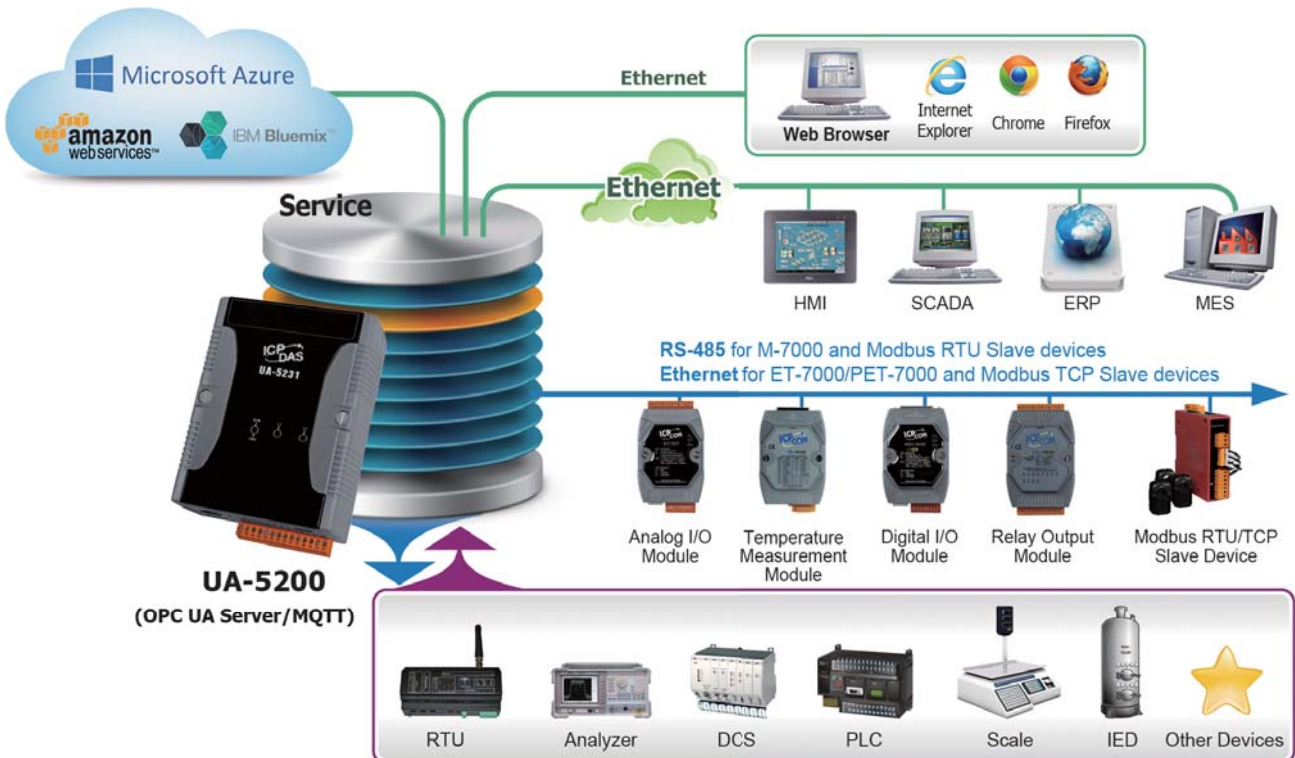

■ Functions

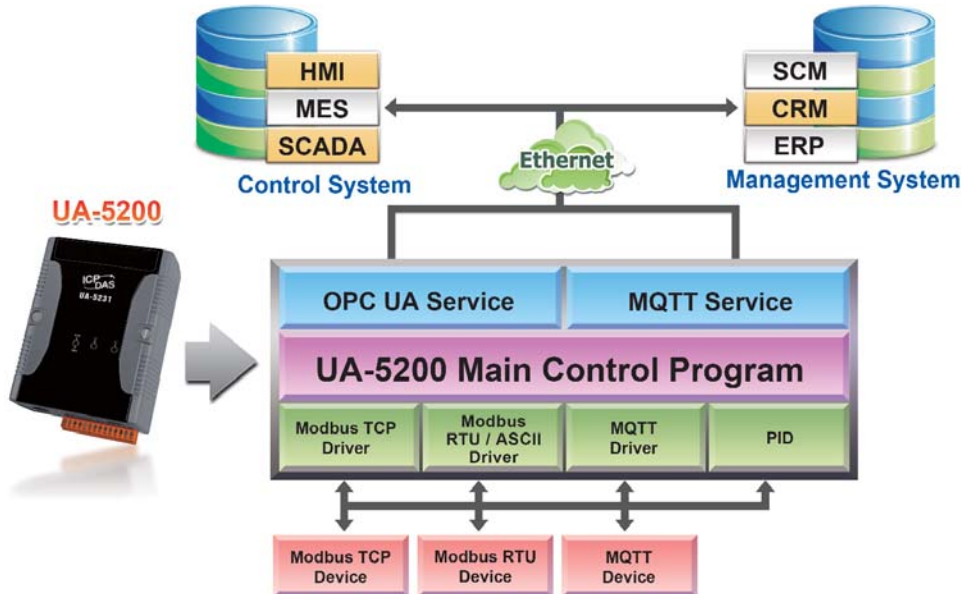

■ Web-based UI

With the Web-based User Interface, users can log in and configure the controller via a normal web browser that only need a mobile device or computer with web browsing capabilities.

■ OPC UA Server: IEC 62541 Standard

The OPC UA Server certified by the OPC Foundation can assist the integration for the local-end devices, actively upload data to the application system, and support to across the multiple platforms.

■ PID Logic Operation

The PID function can dynamically combine the remote I/O devices for the PID logic control to provide temperature control and case field solutions.

■ Support Modbus TCP/RTU/ASCII Master

Through the controller's RS-485, RS-232 and Ethernet ports can connect to the Modbus TCP/RTU/ASCII Slave devices. Build systems with scalability and flexibility to meet the diverse application needs and expansion at any time.

■ MQTT Broker Inside

Compliance with MQTT v3.1.1 protocol. Support MQTT message distribution management. Users do not need to build Broker system when using MQTT communications.

■ Support MQTT Protocol

Support MQTT to allow the IoT devices communicating with the OPC UA system and the UA-5200 conducting the data acquisition and management; and also can convert and publish the devices' data under the UA-5200 to the IoT system.

UA-5200 Function Overview		
Web-based UI	Built-in Web-based User Interface	
Flexible System Configuration	Variable Table/Communication Task Dynamic Editor	
OPC UA	Compliance with IEC 62541 Standard Cross-platform Transmission Security SSL Encryption Active Transmission Support Redundancy Support Remote Function Call	
MQTT Broker Inside	Built-in MQTT Broker, Compliance with MQTT V.3.1.1 Protocol	
PID Logic Operation	Dynamic Combination of I/O Devices for PID Logic Control	
Service (Output) Up to Interact with the Host	Protocol	OPC UA Server MQTT Client
	Interface	Ethernet Data Transmission
Driver (Input) Down to Interact with the I/O Modules	Protocol	Modbus RTU/ASCII/TCP MQTT
	Interface	RS-232/RS-485 Ethernet Data Transmission

■ OPC UA: New Generation Industrial Communication Standard

OPC UA is the interoperability standard based on **Industry 4.0** for security, reliable multi-vendor, multi-platform data exchange for Industrial Automation. It extends the classical OPC communication protocol, enabling data acquisition and information modeling and communication between the plant floor and the enterprise reliably and securely.

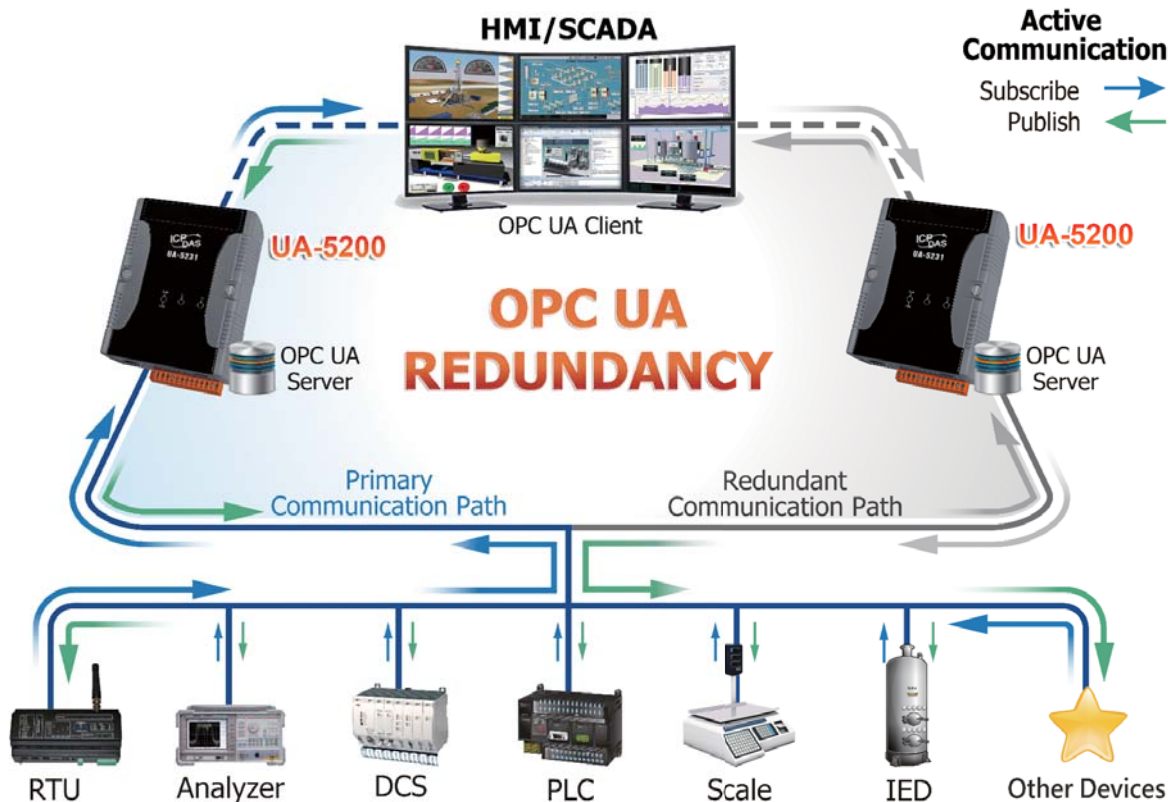

Key Features of OPC UA:

■ Platform Independent Data Communication

OPC UA is designed to be independent of the platform. Using SOAP/XML over HTTP, OPC UA can be deployed on Linux, Windows XP Embedded, Windows 7, and Classical Windows platforms.

■ Unified Access

OPC UA integrates existing OPC specifications DA, A&E, HDA, Commands, Complex data, and Object Types in one specification. This reduces system integration costs by providing a common architecture for accessing information.

■ Standardized Communication via Firewalls and Internet

OPC UA uses message based security which means messages can be relayed through HTTP, UA TCP port or any other single port available.

■ Reliability & Redundancy

OPC UA implements a configurable timeouts, error detection, and communication failure recovery. OPC UA allows redundancy between applications from different vendors to be deployed.

■ Security

OPC UA is Secure-by-default, encryption enabled, and uses advanced certificate handling which includes Authentication, Authorization, Confidentiality, and Integrity.

MQTT: Active M2M Transmission Mechanism

MQTT is a method of **Machine to Machine (M2M)** communication by writing and retrieving application-specific data (messages) to and from queues, without having a private, dedicated connection to link them. It simplifies and accelerates the cloud-based integration of diverse applications data between IIoT devices under assured, secure and reliable exchange of information circumstance. Using MQTT in IIoT devices not only dramatically simplifies the creation and maintenance of Industrial application but also makes connectivity for the "internet of things" and mobile devices easily, and achieve the smart automation based on **Industry 4.0**.

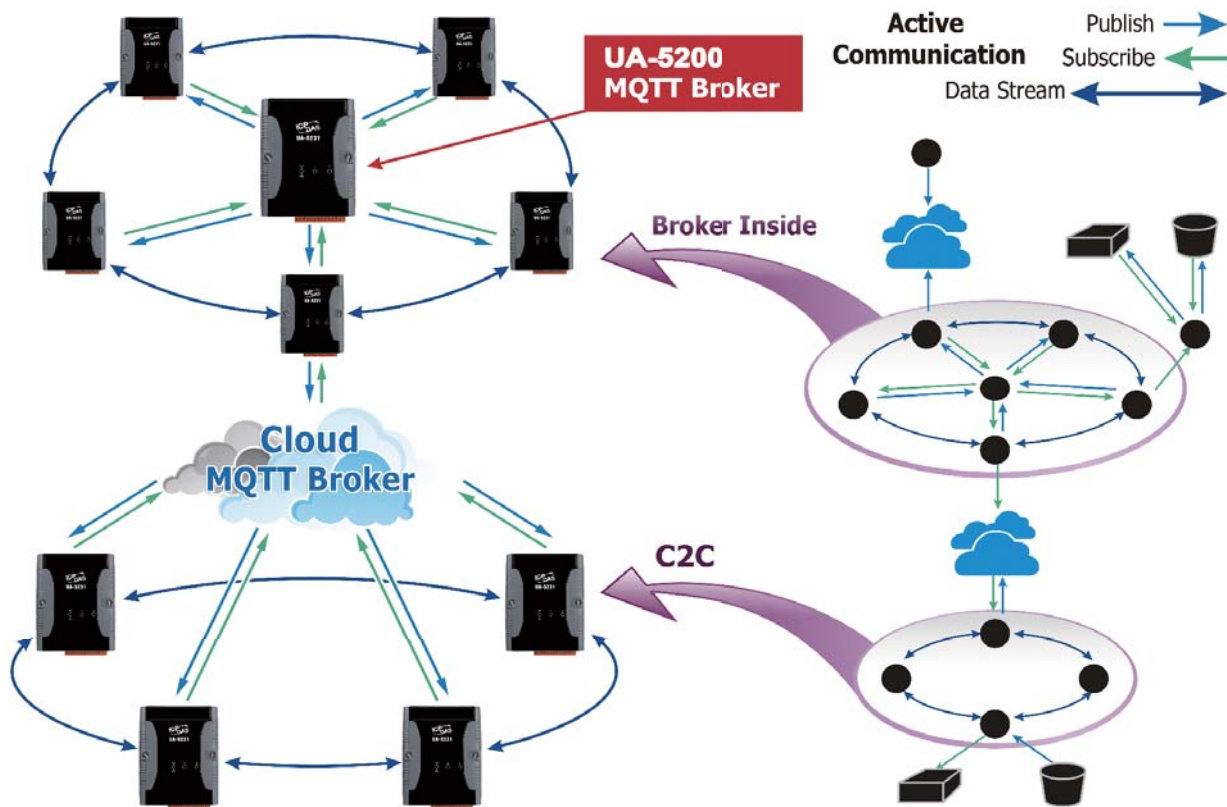

Key Features of MQTT:

■ Rapid, Seamless Connectivity

Rapid, seamless connectivity of information with a single, robust and trusted messaging backbone for dynamic heterogeneous environments.

■ Secure, Reliable Message Delivery

Secure, reliable message delivery that preserves message integrity and minimizes risk of information loss.

■ High-performance Deployment

High-performance and scalable message transfer to meet the demands of today's enterprise and beyond.

■ Simplified Management and Control

Simplified management and control for better control and usability.

■ Cost Effective

Cost effective of ownership by reducing cost of integration and accelerating time to deployment.

Solutions

► Solution 1

(Modbus ↔ OPC UA)

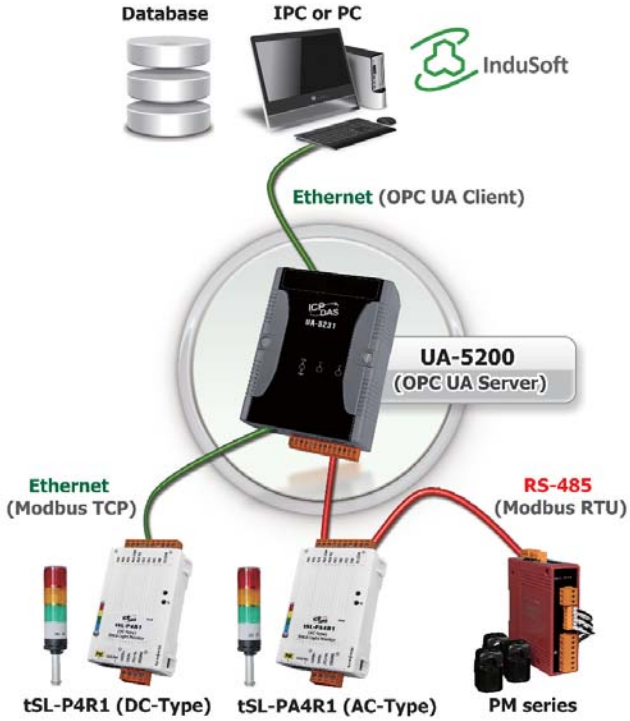

► Solution 2

(Modbus ↔ MQTT)



► Solution 3

(MQTT ↔ OPC UA)



► Solution 4

(MQTT ↔ MQTT)



Applications

Robotic Arm Co-operation Application

This application allows two robotic arms interactive communication and coordinated operation through the MQTT, and do the data analysis and system monitor/control with the database of SQL, Big Data or SCADA through the OPC UA.

1. Use two UA-5231 to read/control two robotic arms.
2. The smart phone/tablet can read the data of robotic arms through MQTT.
3. Two UA-5231 read data of each other (Active Communication) through MQTT.
4. Two UA-5231 provide data to Database (SQL/ big data) or SCADA for application/analysis through OPC UA.

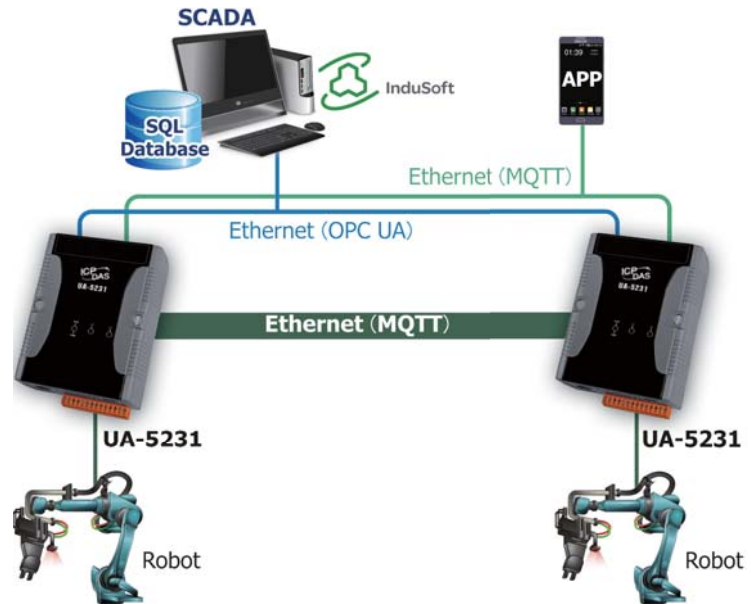

IoT Application of MES

The Manufacturing Execution System (MES) communicates the factory equipments via OPC UA Client, and the OPC UA Service of the UA-5200 series can seamlessly integrate the system and equipments.

1. The OPC UA Service of UA-5231 can perfect convergence up to the MES
2. The Modbus RTU Master Driver of UA-5231 has great ability to integrate the Modbus RTU Slave devices that happen to be the majority equipments in the market.

The MES is the main solution for today's factory system, and the UA-5200 series IIoT Communication Server is the best choice for the IIoT factory solution.

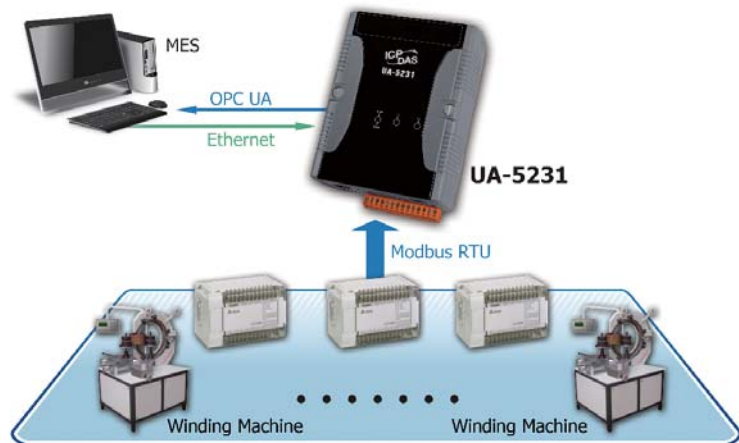

Pumping Station IoT Application

This application is mainly to manage the pumping device data from many stations. It uploads the data of all pumping stations to the control center using the UA-5231 IIoT Communication Server, and centrally manages/configures with the IWS software.

1. Up: using UA-5231 OPC UA Service
2. Down: using UA-5231 ModbusTCP Client Driver.
3. The IWS configuration software directly supports OPC UA Client, it can easily integrate with the UA-5231 to collect data of the Modbus devices in the front end.

In this case, the UA-5231 shortens the configuring and adjusting time; without the complicated PC configuration, the UA-5231 directly connect the Modbus and OPC UA Server by clicking on the web to complete configuration easily, time-saving and efficiently.



■ Hardware Specifications

Model	UA-5231	UA-5231M	UA-5231M-3GWA
System Software			
OS	Linux Kernel 3.2.14		
Embedded Service	SFTP server, Web server, SSH		
CPU Module			
CPU	ARM CPU, 1.0 GHz		
DDR3 SDRAM	512 MB		
Flash	512 MB		
FRAM	64 KB		
Expansion Flash Memory	microSD socket with one 4 GB microSD card (support up to 32 GB microSDHC card)		
RTC (Real Time Clock)	Provide second, minute, hour, date, day of week, month, year		
64-bit Hardware Serial Number	Yes, for Software Copy Protection		
Dual Watchdog Timers	Yes		
LED Indicators	4 LEDs (Power, Running and 2 user defined LEDs)		
Rotary Switch	Yes (0 ~ 9)		
VGA & Communication Ports			
VGA & Communication Ports	Yes, resolution: 640 × 480, 800 × 600, 1024 × 768, 1280 × 720		
Ethernet	RJ-45 x 1; 10/100/1000 Based-TX (Auto-negotiating, Auto MDI/MDI-X, LED indicators)		
USB 2.0 (host)	1		
Console Port	RS-232 (Rx, Tx and GND); Non-isolated		
ttyO2	RS-485 (Data+, Data-); Non-isolated		
ttyO4	RS-232 (Rx, Tx and GND); Non-isolated		
ttyO5	RS-485 (Data+, Data-); 2500 VDC isolated		
Mechanical			
Dimensions (W x L x H)	91 mm x 132 mm x 52 mm	117 mm x 126 mm x 58 mm	
Installation	DIN-Rail Mounting		
Environmental			
Operating Temperature	-25 ~ +75°C		
Storage Temperature	-40 ~ +80°C		
Ambient Relative Humidity	10 ~ 90% RH (non-condensing)		
Power			
Input Range	+12 ~ +48 Vdc		
Consumption	4.8 W	6.5 W	
GSM System			
Frequency Band	-	GSM: 850/900/1800/1900 MHz	
GPRS Connectivity	-	GPRS class 12/10; GPRS station class B	
Data Transmission	-	Downlink transfer: Max. 85.6 kbps; Uplink transfer: Max 42.8 kbps	
3G System			
Frequency Band	-	WCDMA 850/900/1900/2100 MHz	
Data Transmission	-	WCDMA / HSPA+, Download: Max. 14.4 Mbps; Upload: Max 5.76 Mbps	

Software Specifications

Model	UA-5200 Series
OPC UA	
OPC UA Server	<ul style="list-style-type: none"> ● OPC Unified Architecture: 1.02 ● Core Server Facet ● Data Access Server Facet ● Method Server Facet ● Client Redundancy Facet ● UA-TCP UA-SC UA Binary ● User Token User Name Password & X509 Certificate ● Security Policy <ul style="list-style-type: none"> ◦ None ◦ Basic128Rsa15 <ul style="list-style-type: none"> • Sign • Sign & Encrypt ◦ Basic256 <ul style="list-style-type: none"> • Sign • Sign & Encrypt <p>Recommend to keep the maximum number of sessions within 20 connections.</p>
Modbus Master	
Modbus TCP	To read or control the devices that support standard Modbus TCP Slave protocol. Recommend to keep the maximum number of devices within 100 connections.
Modbus RTU/ASCII	A max. of 3 ports: ttyO2, ttyO4, ttyO5 to connect other Modbus RTU Slave devices (e.g. M-7000). Recommend no more than 32 devices per port for better communication quality.
MQTT	
MQTT Client	Connect the MQTT Broker to read/control the devices supporting the MQTT protocol.
MQTT Service	Connect the MQTT Broker to externally read/control the devices supporting other protocols that linking with the UA-5200 series.
MQTT Broker	Compliance with MQTT v3.1.1 protocol. Support MQTT message distribution management. Recommend to keep the connection number of Client within 400.
Virtual Device	
PID Function	Combine the remote I/O devices for the PID logic control system.

Appearance

UA-5231

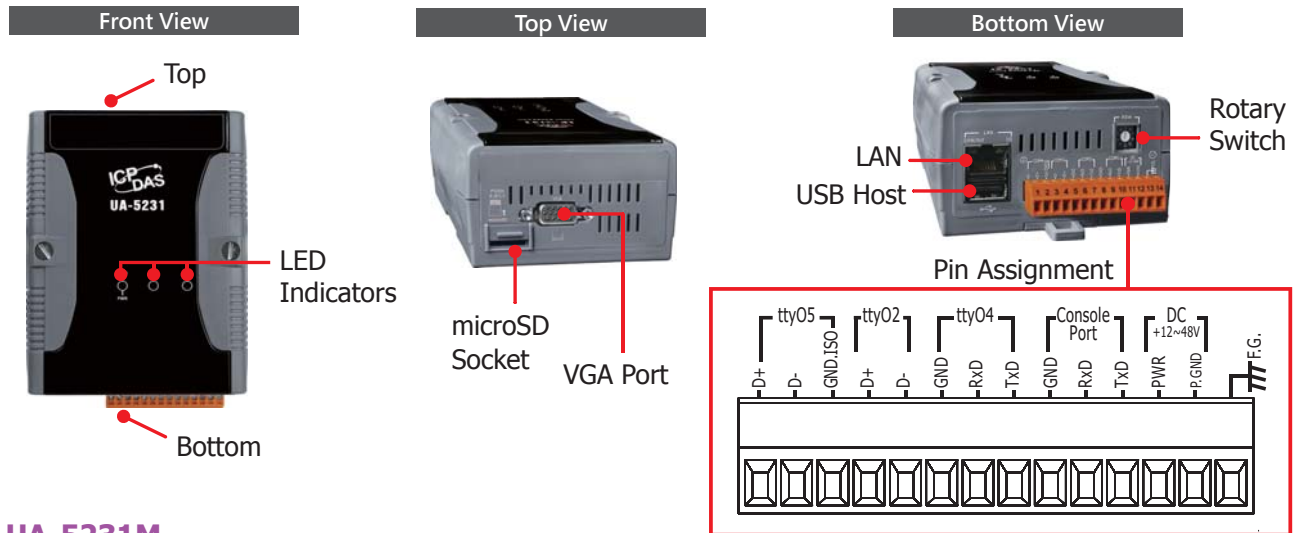

UA-5231M

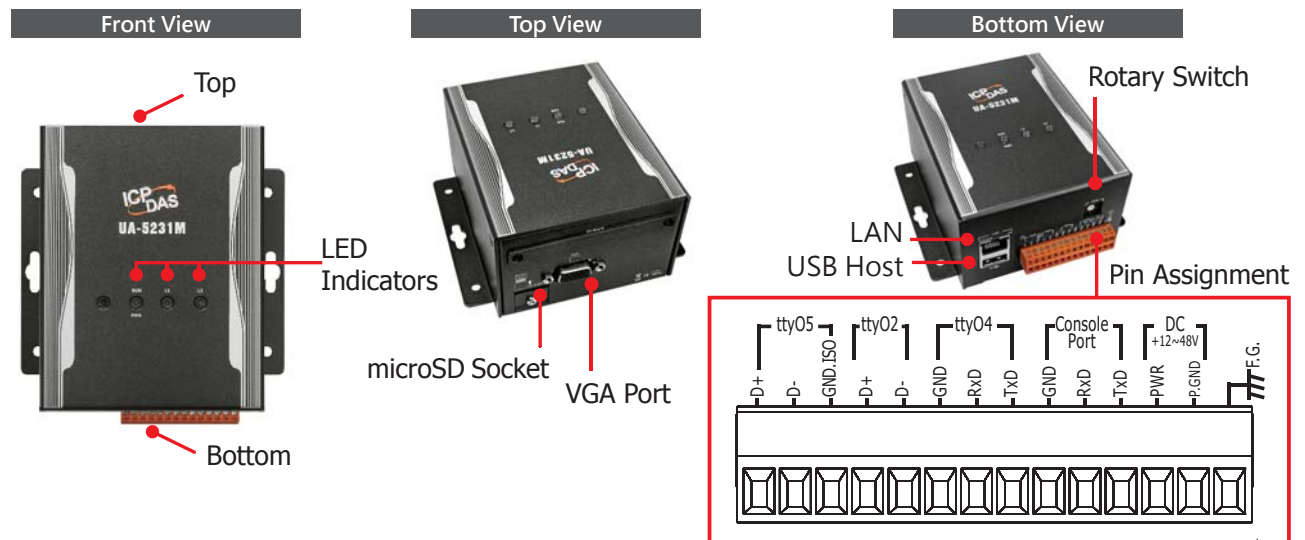

UA-5231M-3GWA

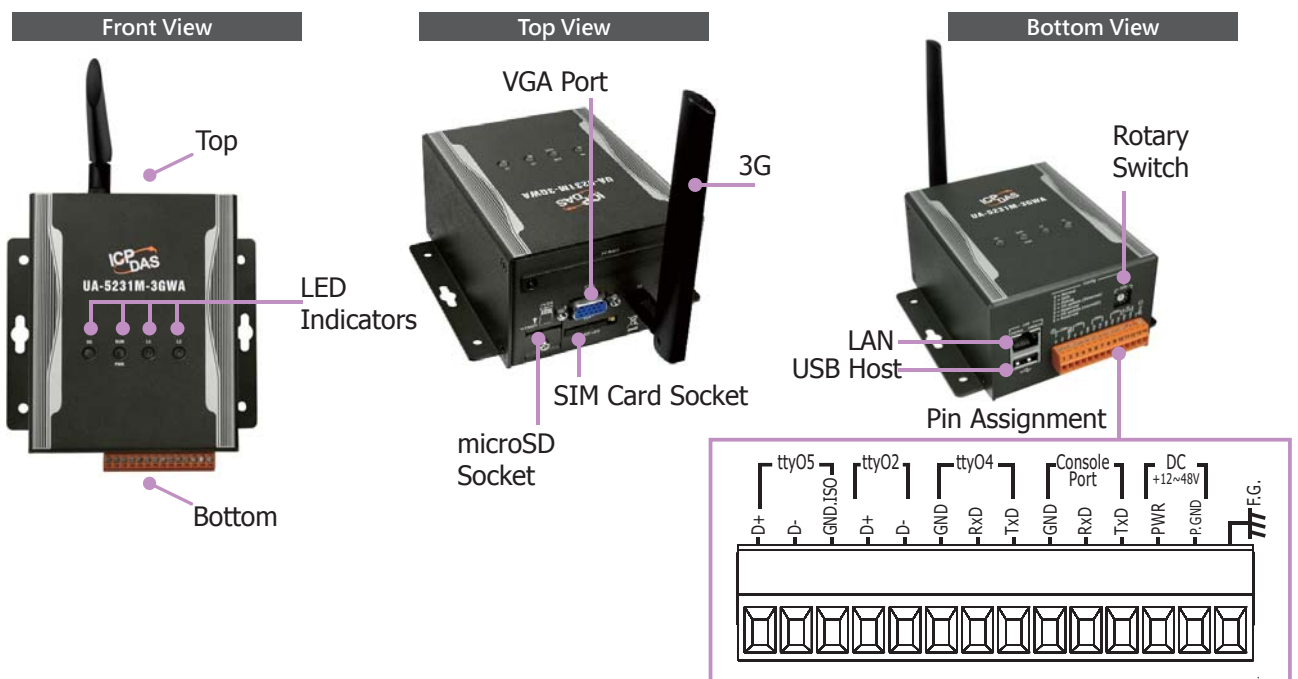

■ Dimensions

UA-5231

Unit: mm

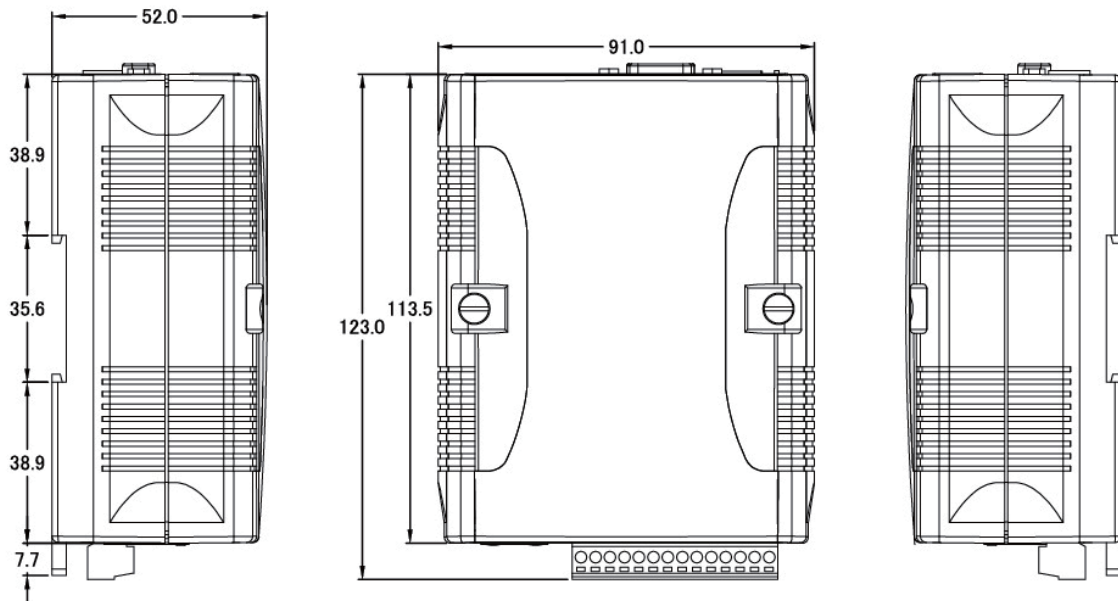

UA-5231M / UA-5231M-3GWA

Unit: mm

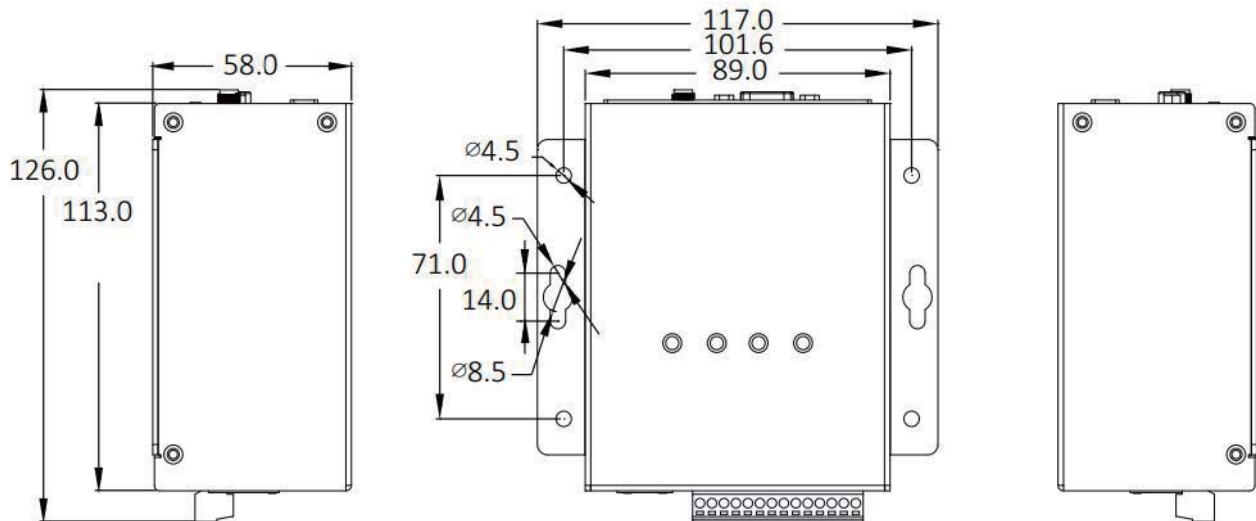

■ Ordering Information

UA-5231 CR	IIoT Communication Server (RoHS) Art. no. 146180
UA-5231M CR	IIoT Communication Server (Metal) (RoHS) Art. no. 154540
UA-5231M-3GWA CR	IIoT Communication Server (Metal) Support 3G Wireless Communication (RoHS)

■ Option Accessories

DIN-KA52F	24 V/1.04 A, 25 W Power Supply with Din-Rail Mounting
MDR-20-24	24 V/1 A, 24 W Power Supply with DIN-Rail Mounting